

SINO AGE DEVELOPMENT TECHNOLOGY

Surface Roughness Tester SR220

Operation Manual



CONTENT

1	OVERVIEW	3
1.1	MEASUREMENT PRINCIPLE	3
1.2	MEASUREMENT PRINCIPLE	3
1.3	STANDARD PACKAGE.....	4
1.4	LAYOUT OF THE INSTRUMENT	5
1.4.1	<i>Main unit</i>	5
1.4.2	<i>Pickup</i>	6
1.4.3	<i>Display</i>	6
1.4.4	<i>Function of key</i>	6
1.5	BASIC CONNECTION METHOD	7
1.5.1	<i>Assembling and dis-assembling of the pickup</i>	7
1.5.2	<i>Charger and battery charging</i>	8
2	SETTING FOR INITIAL USAGE	8
2.1	CLOCK SETTING	9
2.2	UNITS OF MEASUREMENT	9
2.3	LANGUAGE SELECT	10
3	MEASUREMENT OPERATION	10
3.1	PREPARATION BEFORE MEASUREMENT.....	10
3.2	SWITCH ON.....	11
3.3	STYLUS POSITION	11
3.4	CALIBRATION	11
3.5	GETTING STARTED.....	12
3.5.1	<i>Start measuring</i>	12
3.6	RESULT DISPLAY	13
3.6.1	<i>Parameters</i>	13
3.6.2	<i>Profile Graphic</i>	13
3.6.3	<i>Store/read measurements</i>	13
3.6.4	<i>Print measurements</i>	14
3.6.5	<i>Connected with PC</i>	15
3.6.6	<i>Remote measurement</i>	16
3.6.7	<i>SD card</i>	16
4	MAIN MENU.....	17
4.1	MEASUREMENT CONDITION SETTING	17
4.2	SYSTEM SETTING	17
4.3	SOFTWARE INFORMATION.....	18
5	ROUTINE MAINTENANCE AND CARE	18
5.1	PICKUP	18
5.2	HOST.....	18
5.3	BATTERY	18
5.4	CALIBRATION SPECIMEN	18
6	COMMON FAULTS	19
7	ACCESSORIES.....	19
7.1	HEIGHT SUPPORT AND PICKUP HOLDER	19
7.2	HEIGHT STAND	20
7.3	STANDARD PICKUP.....	20
7.3.1	<i>Size</i>	21
7.3.2	<i>Operating instructions</i>	21
7.3.3	<i>Calibration</i>	21

7.3.4	<i>Precautions</i>	21
7.4	CURVE SURFACE PICKUP	21
7.4.1	<i>Size</i>	22
7.4.2	<i>Operating instructions</i>	22
7.4.3	<i>Measurement</i>	22
7.4.4	<i>Calibration</i>	22
7.4.5	<i>Precautions</i>	23
7.5	GROOVE BOTTOM PICKUP	23
7.5.1	<i>Size</i>	23
7.5.2	<i>Operating instructions</i>	23
7.5.3	<i>Calibration</i>	24
7.5.4	<i>Precautions</i>	24
7.6	SMALL BORE PICKUP	24
7.6.1	<i>Size</i>	24
7.6.2	<i>Operating instructions</i>	24
1.1.1	<i>Calibration</i>	25
7.6.3	<i>Precautions</i>	25
7.7	EXTENSION ROD	25
8	KEY TECHNICAL PARAMETERS	25
8.1	STANDARD CODE AND NAME	26
8.2	ROUGHNESS PARAMETERS RANGE.....	26
9	REFERENCES	26
9.1	TERMS.....	26
9.1.1	<i>Terms</i>	26
9.1.2	<i>Traversing length</i>	27
9.2	DEFINITION OF PARAMETERS	27
9.2.1	<i>Arithmetic Mean Deviation of Profile Ra</i>	27
9.2.2	<i>Root-mean-square Deviation of Profile Rq</i>	28
9.2.3	<i>Maximum height of the profile Rz</i>	28
9.2.4	<i>Total Peak-to-valley Height Rt</i>	28
9.2.5	<i>Maximum profile peak Rp</i>	28
9.2.6	<i>Maximum valley depth Rv</i>	29
9.2.7	<i>Average distance of profile single peak RS</i>	29
9.2.8	<i>Average width of profile unit RSm</i>	29
9.2.9	<i>Ten point height for profile microscopic irregularities RzJIS</i>	30
9.2.10	<i>Maximum profile height RyJIS</i>	30
9.2.11	<i>Profile inclination Rsk</i>	30
9.2.12	<i>Average peak-to-valley height R3z</i>	30
9.2.13	<i>Rmax</i>	30
9.2.14	<i>Peak count Rpc</i>	30
9.2.15	<i>Profile support rate curve Rmr</i>	31
9.2.16	<i>Profile support length rate Rmr(c)</i>	31
9.3	SAMPLING LENGTH SELECTION RECOMMENDATION FORM.....	31

1 Overview

This handheld surface roughness tester is a new product and adopts the most mainstream processor chips and high-technologies to achieve a comprehensive upgrade and improvement, with 2.7" OLED, Bluetooth, SD card, wireless remote control of measurements, MICRO-USB port, to enhance the quality of the instrument significantly. This instrument is small handheld type suitable for production site measurement and mobile measurement, easy to operate, comprehensive function, fast measurement, accurate and stable, easy to carry, which can be used to measure the main parameters of the latest international standards. This product is in rigorous compliance with the international standard. This product has multi optional accessories and can be connected to a PC and wireless Bluetooth printer.

1.1 Measurement Principle

To measure the surface roughness of the workpiece, place the pickup on the surface of the workpiece, and then start the tester. The precision driver inside the instrument will drive the pickup to slide at uniform linear speed along surface to be measured. The pickup will feel the roughness of surface to be measured through the built-in sharp stylus. At this time, the roughness of the workpiece surface to be measured will cause displacement of the stylus, which causes change to the inductance amount of the coil of pickup, generating the output analog signal of the phase sensitive detector which is proportional to the roughness of measured surface. This signal is fed to the data acquisition system after amplification and level conversion. The collected data is filtered and the parameters are computed via the ARM chip. The measurements are displayed on the OLED. A Bluetooth printer can be connected wirelessly. All measurement parameters can be printed. This tester can also communicate with the PC through the data cable, so as to perform advanced analysis using PC software.

1.2 Measurement Principle



- ✓ 28 measurement parameters: Ra, Rq, Rz, Rt, Rp, Rv, RS, RSm, Rz(JIS), Ry(JIS), RSk, R3z, Rmax, RPc, Rmr, Rku, RΔa, RΔq, Rδc, Ry; Rk, Rpk, Rvk, Mr1, Mr2, A1, A2, V0;
- ✓ 320μm large-range precision inductive pickup;
- ✓ RC, PC-RC, GAUSS, D-P filtering;
- ✓ ISO, DIN, ANSI, JIS standard;
- ✓ 2.7" large screen 128×64 dot matrix OLED display, no backlight, no dead ends, displaying all parameters and graphics, Chinese/English menus;
- ✓ Common chip for instrument control and data processing;
- ✓ Built-in memory for store of 20 groups of measurements;
- ✓ External SD card for expandable mass storage of data;
- ✓ Built-in wireless remote module for remote measurement;
- ✓ Built-in standard Bluetooth module for wireless connection of Bluetooth printer to print all parameters and graphics;
- ✓ Built-in standard MICRO-USB interface for communication with the PC, with dedicated software

for analysis of measurement results;

- ✓ Built-in lithium polymer rechargeable batteries and charging protection circuit;
- ✓ Integrated, compact, portable;
- ✓ Automatic shutdown and operation prompt;
- ✓ Complete accessories/fitting. Optional curve surface pickup, groove bottom pickup, small bore pickup, super-small-small bore pickup, tooth surface pickup, column, trimming platform, extended rod, lateral transfer bar etc.

1.3 Standard Package

Description	Picture	Description	Picture
Main unit		Height support	
Standard pickup		Calibrate specimen	
Pickup holder		Calibrate specimen holder	
Screw driver		Charger	

Data cable		Remote controller	
------------	---	-------------------	---

1.4 Layout of the instrument

1.4.1 Main unit

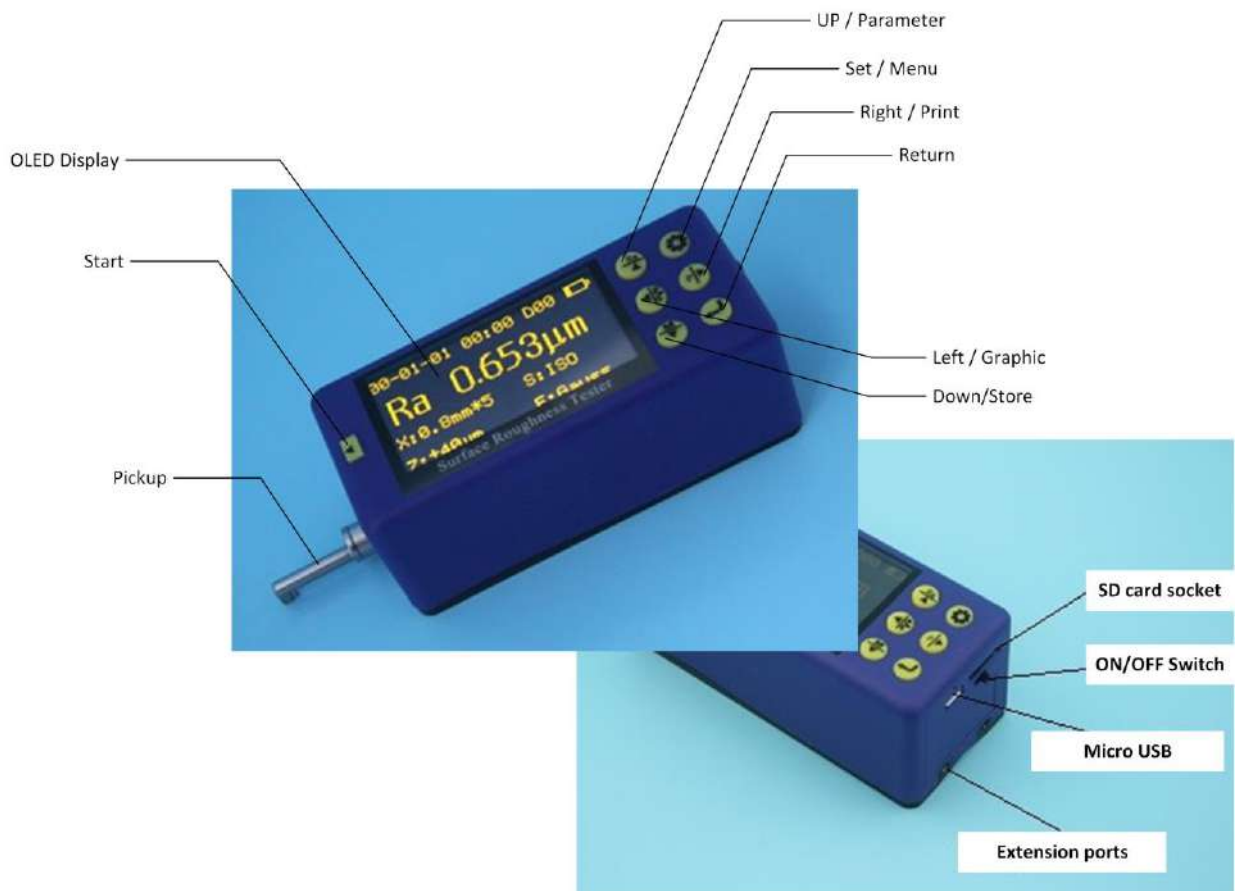

1.4.2 Pickup

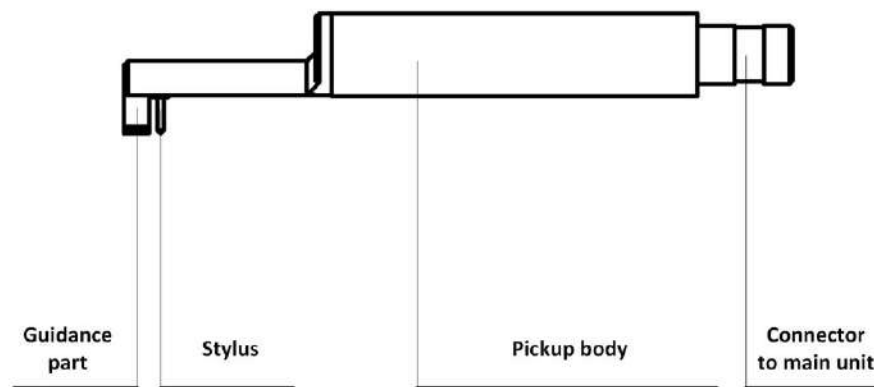

1.4.3 Display

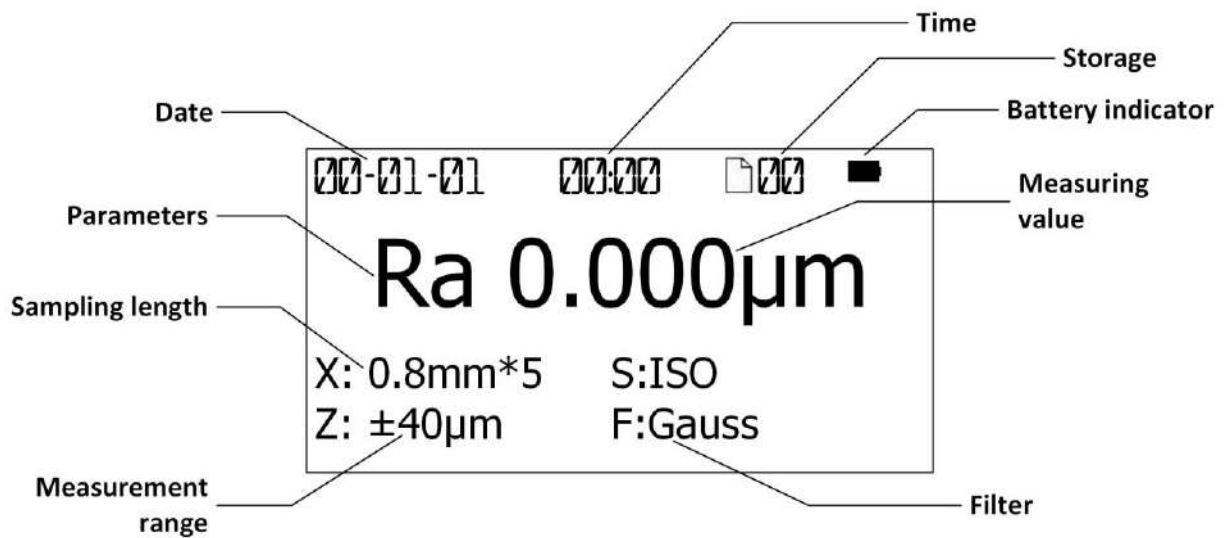

1.4.4 Function of key

: Start: to start the measuring.

: Up/Parameter:

- 1, Press this button in the main screen to enter the Parameters screen, displaying all measurements of the parameters. Press Set to exit;
- 2, After entering the other screens, the button will be set as the Up arrow.

: Down/Store:

- 1, Press this button in the main screen to enter the Record Storage screen;
- 2, After entering the other screens, the button will be set as the Down arrow.

: Left/Graphic:

- 1, Press this button in the main screen to enter Graphic screen, displaying various measurement graphics and support rate curves etc;

2, After entering the other screens, the button will be set as the Left arrow.



: Right/Print:

1, Press this button in the main screen to start the wireless Bluetooth printer to print all measurements;

2, After entering the other screens, the button will be set as the Right arrow.



: Set/Menu:

1, Press this button in the main screen to enter fast Setting of measurement conditions, to set and change various measurement conditions following the cursor;

2, Press and hold this button to enter the main menu;

3, After entering the other screens, the button will be set as Exit and Return in general.



: Return:

1, Press this button in the main screen to display the stylus position. Press this button again to exit the stylus position;

2, In the other screens, press this button to confirming the setting/modification or exit this screen;

Note on arrows:

Function of Up/Down/Left/Right arrows: In screens other than the main screen: press Up/Down arrow to switch and choose item; press Left/Right arrow to adjust the set number and value.

1.5 Basic connection method

1.5.1 Assembling and dis-assembling of the pickup

As shown in the figure, hold the connection part of top guide tray and pickup main body (stylus is downward), plug in the mainframe's connecting socket according to the figure connecting line direction, press lightly to the end till stable connection. When taking out, please disconnect pickup from connecting socket, then take the pickup out from drive slowly. All the operation process should be careful to avoid pickup breakage.



Assembling and dis-assembling of the pickup

Note: 1. Pickup stylus is the key accessory of this instrument, please pay high attention to it when using.



2. During the process of pickup assembling and dis-assembling, please do not touch the stylus to avoid breakage which would affect the measurement.
3. During the process of pickup assembling, please make sure that the connection is reliable.

1.5.2 Charger and battery charging

When the battery is low on the display or the tester cannot boot, charge in time. To charge, connect the charger to 220V/50Hz mains power, and then connect the charger plug into the micro USB socket at back of the instrument, charging will start. During charging, the LED (red) is ON; the LED (green) is ON after the battery is fully charged. Disconnect the power. It takes about 3 to 4 hours to charge. The input voltage of charger is 100 ~ 240V, 50/60Hz AC, maximum current: 0.2A; output 5V DC, maximum charging current of about 500 mA. This instrument uses a lithium polymer battery, no memory effect. You can charge at any time, and the tester can work normally during charging.

Note: 1.If measure on charging station, please make sure that the connecting cable's place would not affect the measurement operation.



- 2.Please charge as soon as possible during the low voltage situation, and cut off power as soon as possible after full charge.
 - 3.The battery switch is off when the instrument leave factory.
 - 4.If the instrument work in-properly, and turn off / turn on the machine can not help to solve the problem, then please turn off the battery switch of the instrument backside, and restart after 10seconds.
-

2 Setting for initial usage

To use this instrument for the first time, the Clock Setting screen appears after booting. Press Left/Right to move between items. Press Up/Down to adjust the time. After setting, press Enter to confirm and exit. The clock setting is complete.

The following is the main screen, which appears after booting or before/after measuring. The main screen mainly includes measurement parameters and various measurement conditions, such as sampling length, evaluation length, range, filters and measurement units.

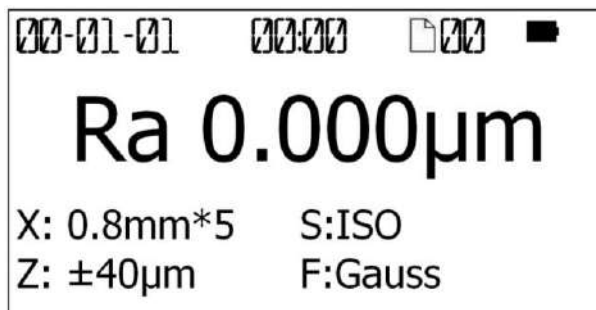

2.1 Clock Setting

In main screen, press and hold Set button to enter the main menu. Select “System Set” and press Return to enter System Set menu, then select “Clock Set” and press Return to enter Clock Setting screen.

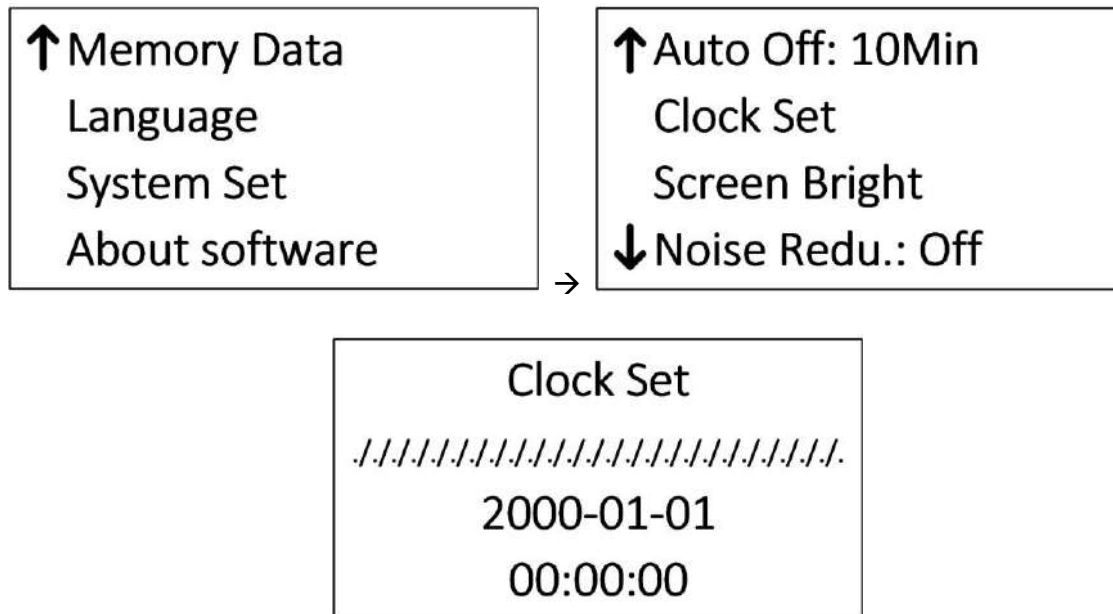

In general, press Up/Down arrow to switch and choose the item; press Left/Right arrow to adjust the number.

2.2 Units of measurement

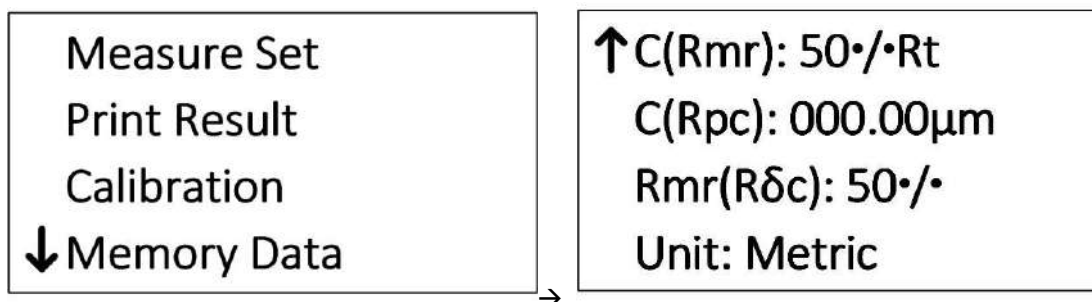

In main screen, press and hold Set to enter the main menu; then select “Measure Set” and press Return. Press Up/Down to select the Unit. Press Return to directly change the units of measurement. Press Set to exit.

2.3 Language Select

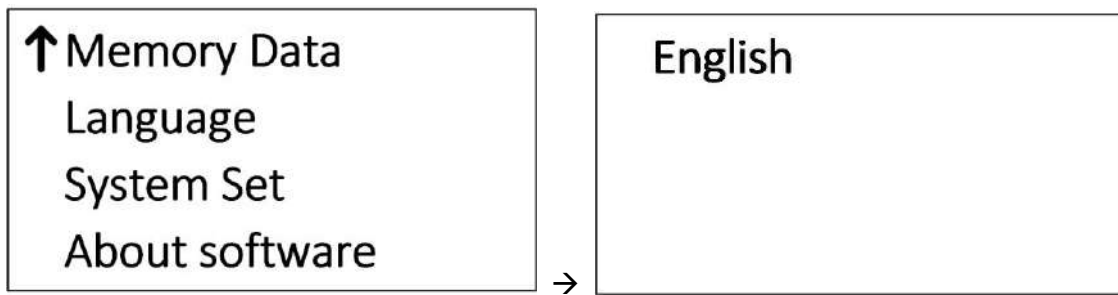

In main screen, press and hold Set to enter the main menu. Press Up/Down and select "Language". Press Return to enter Language Select screen. Press Return to confirm and press Set button to exit.

3 Measurement Operation

3.1 Preparation before measurement

- Check the battery voltage after booting;
- Wipe the surface of the workpiece to be measured with a soft clean cloth;
- Keep the slide trace of the pickup perpendicular to machining texture of the measured surface of the workpiece.
- Keep the instrument and the pickup parallel with the measured surface during measuring.
- During measuring, keep it away from vibration, magnetic fields, wind and other external environments which will affect the measurements.



Measurement direction

Instruction: Correct and normative operation is the precondition to obtain precise measurement.

3.2 Switch on

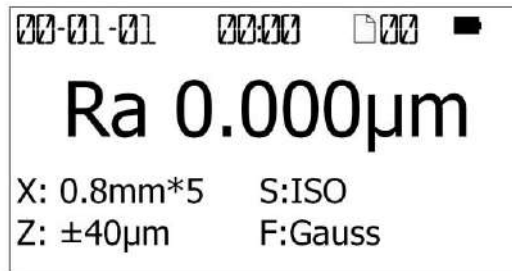

Starting up display

After booting, the default parameter settings, units of measurement, filter, range, sampling length etc will automatically display, as shown in the following figure:

Instruction: The default setting will display after the first booting display, and the contents and measurements set by the user prior to the previous shutdown will display after the next booting.

3.3 Stylus position



In main screen, press Return button to check the stylus position of the pickup. In general, for measuring in the plane, it is not necessary to adjust the position of the stylus. After measuring, the error of results is within the range of the instrument.

The Stylus Position screen is used for the column, to adjust the height of the instrument up/down as required, in order to determine whether the pickup has contacted the measured surface. The measuring may begin as the point is near the zero point.

3.4 Calibration

Before the measuring, calibration of the instrument using Calibration specimen is usually required. This instrument is accompanied with a calibration specimen. Before the measuring, test the calibration specimen using the instrument. Normally, as the difference between the measurement and the value of the specimen is within the range of the instrument, the measurement is valid. It is unnecessary to adjust. The tester can be used for direct measuring.

If the difference between the measurement and the value of the calibration specimen exceeds the range of the instrument, or the user requires higher measurement accuracy, you can use the calibration function to correct the measurements to improve the accuracy.

Calibration procedure:

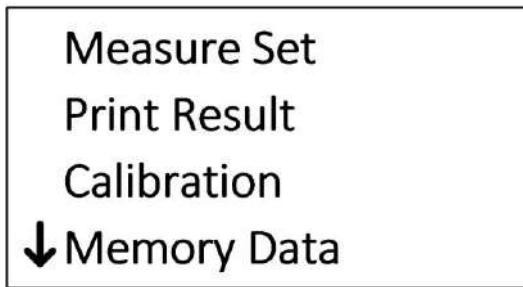

In main screen, press and hold Set button to enter the main menu. Press Up/Down to select “Calibration”. Press Return to enter Display Calibration Setting screen.



Press Up/Down to change the row. Select the desired range to calibrate. Press Left/Right to adjust the setting, then press Return to confirm the change.

Estimate the value for correction depending on the error of the measurements. Input the measurement range and then quit. Measure again and adjust, until the measurements are satisfied. The calibration is subject to each range. Calibrate each range independently. The calibration results are stored in the instrument's memory, which is not lost after shutdown.

-
- Note: 1, To test the accompanying calibration specimen using proper measuring method, if the actual measurement exceeds $\pm 10\%$ of the calibration value of the specimen, calibrate using the calibration function by the actual error percentage with range less than $\pm 20\%$.
- 2, In general, the instrument has been rigorously tested in the factory, and the display error is less than $\pm 10\%$. In this case, it is recommended that users do not calibrate the tester frequently using the calibration function.
- 3, After the calibration value is set to “00” and confirmed, all calibration settings are clear to restore factory settings.
-

3.5 Getting Started

3.5.1 Start measuring

After completion of the above steps, you can start measuring. In the main screen, press the Start button to begin measuring.

After sampling is completed, filtering of the sampled data starts.

After filtering is completed, all the parameters are calculated.

Tips: If you accidentally touch the power button in the measurement state, the instrument will be shut down. After booting, the pickup will be reset. Do not intervene the pickup now. After resetting, the



instrument is waiting for a new start command.

3.6 Result display

After measuring, all measurements can be observed in the following way:

3.6.1 Parameters

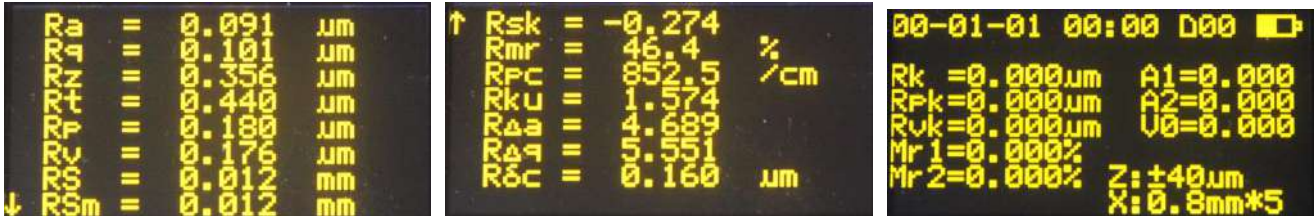

In the main screen, press Up to enter all Parameters Display screen. Press Up/Down to PageUp/Down. Press Set to return to the main screen.

3.6.2 Profile Graphic

In the main screen, press Left arrow to enter the Profile Graphic screen. A sampling length is displayed on each page. Press Left/Right arrow to switch to other sampling lengths. In this screen, press Return to Zoom In/Out the displayed profile. Press Set/Menu button to return to the main screen.

Press Up/Down arrow to switch to the Support Curve screen. Press Set/Menu button to return to the Profile Graphic screen.

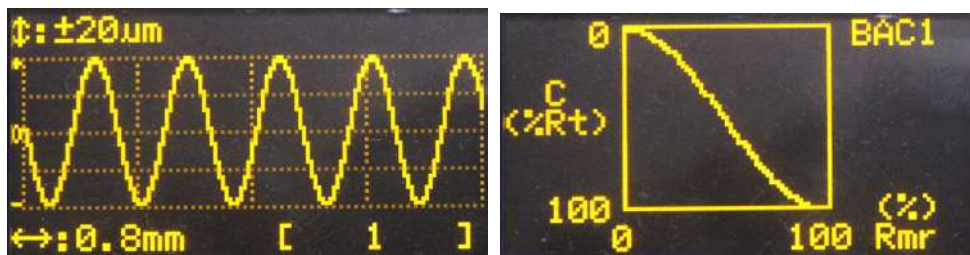

3.6.3 Store/read measurements

In the main screen, press and hold Set button to enter the main menu. Press Up/Down to select "Memory Data". Press Return to enter Memory Data screen.

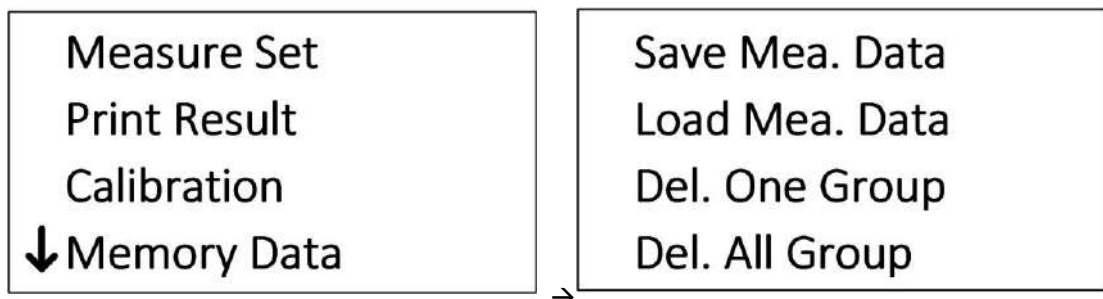

1) Save current data

In the main screen, press Down arrow to directly enter the Store/Read screen. Press Up/Down arrow to store current data. Press Return to enter the Store screen.

Press Return to confirm and store current data. You can modify the group No.

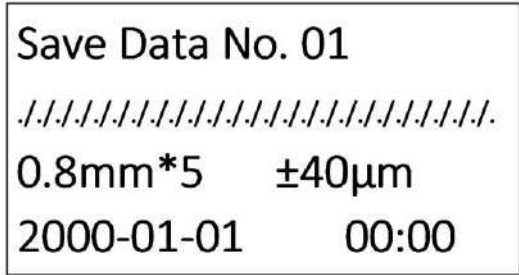

If the space is full, select delete in the “Memory Data” menu. Be careful for deleting data to avoid any mistakes. 20 groups of measurements can be stored.

2) Load history data

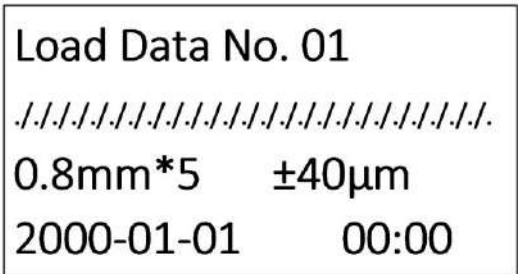

To load the history data, enter “Memory Data” menu, and then select “Load Mea. Data”. Find the desired group No. Press Return to load the data.

3.6.4 Print measurements

The instrument can be fit with optional wireless Bluetooth printer to print all measurements for filing.



After the measurement is complete, press Print button to print the measurements via the wireless Bluetooth printer.

The contents to be printed can be set by the user. Enter the Menu Setting mode, then enter “Print Result” menu item. You can select different presets, or customize the printing content to save time and paper.

Before printing, select a proper printer. First, install the optional printer, and turn on the power. Place the printer near the PC. Then, select "Printer Pair" from "Print Results" menu item. Press Return to pair the printer and the roughness tester. After about 3 seconds, display "Pairing successful". Press Set to return to the main screen and you can print.

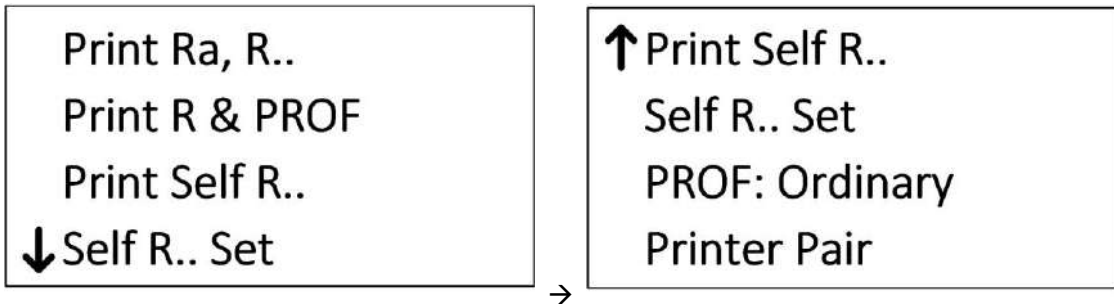

Print Setting screen

1) Start printing

In the main screen, press Right arrow to print the measurement parameters and profile graphics to the printer.

2) Paper

SR200 Surface Roughness Tester	
Date	2008-01-01
Time	13: 08: 09
/r	0.8mm
/n	4mm
Filter	Gauss
Ra	μ m
Rq	μ m
Rz	μ m
Rt	μ m
Rp	μ m
Rv	μ m
RSm	mm
RS	mm
Rz(JIS)	μ m
Rv(JIS)	μ m
RSk	
R3z	μ m
Rmax	μ m
RPc	/cm
Rmr(c1=	μ m) %
Rmr(c2=	μ m) %
Rmr(c3=	μ m) %
Rmr(c4=	μ m) %
Vv	×5000
Vh	×500
Ver.	2.0 μ m/10mm
Hor.	20.0 μ m/10mm

All printed contents.

3.6.5 Connected with PC

The instrument can be fit with optional PC analysis software, which has database management, graphics display, parameter display, measurement, print management, document management and other functions.

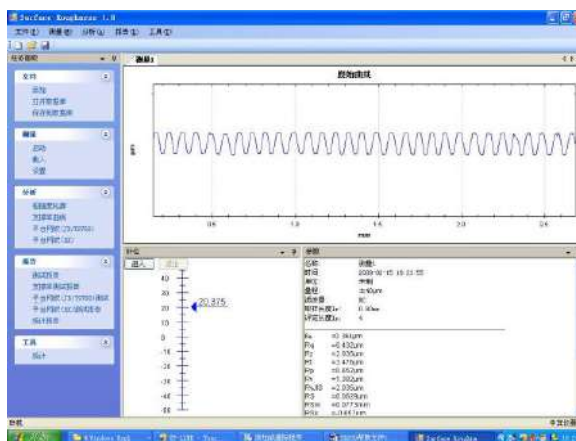

3.6.6 Remote measurement

This instrument has a remote controller to start the measurement. In certain cases, the stability of the measurement can be improved.

Before using the remote controller, first match it. In the main screen, press and hold Set button to enter the Menu Setting mode. Select "System Set". Press Return to enter "System Set" menu item. Select "Remote Pairing". Press Return to pair the remote controller. After about 3 seconds, display "Pairing successful". Press Set to return to the main screen and you can use the remote controller.



3.6.7 SD card

The instrument is equipped with an SD card for remote software upgrade.

Upgrade procedure:

- 1, Receive the new version of software from the manufacturer by e-mail;
- 2, Copy the software to the SD card; (insert the SD card into the USB port of PC via an adaptor).
- 3, Remove the SD card and insert it into the SD card slot at back of the instrument;
- 4, Start the tester and enter the main menu. Select "About Software". Press Enter button to enter the Upgrade screen;
- 5, Select the "SW Update (mSD). Press Enter to start upgrading. You should wait a few minutes. When the progress bar is full and flashing, the upgrade is complete.
- 6, Shut down and re-start.

4 Main Menu

In the main screen, press Set button to enter the main screen.



Main screen

4.1 Measurement Condition Setting

There are two ways to set and modify the measurement conditions. One is fast setting, and the other is setting via the menu.

The fast setting is used for brief and frequent modification during routine measurement to improve the efficiency. In the main screen, press Set to enter fast setting mode. Follow the cursor, and press Up/Down/Left/Right arrow to modify the corresponding measurement condition. Press Return to confirm and exit.

In the main screen, press and hold Set to enter Menu Setting mode. Select "Measure Set" to modify "Sampling Length", "Evaluation Length", "Range", "Filter", "Standard", "Parameters", "C (Rmr)", "C (R_{Pc})", "Rmr (R_{dc})", "Unit of Measurement.



4.2 System Setting

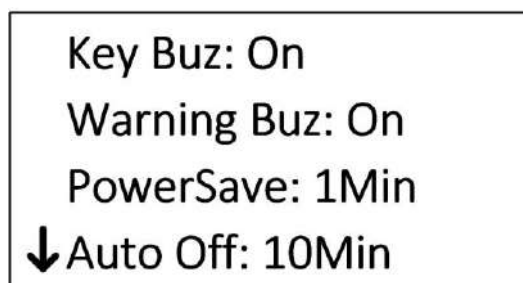

In the main screen, press and hold Set to enter Menu Setting mode. Select "System Set" to enter "System Set" menu item. Under this menu, you can set the following contents:

 Key Buz

- ☐ Warning Buz
- ☐ Power saving time
- ☐ Auto power off time
- ☐ Clock Setting
- ☐ Low-noise measurements
- ☐ Screen test
- ☐ Remote controller paring
- ☐ Surface type selection

Press Return to confirm and exit.

4.3 Software information

The software information contains the model of the instrument, software version, the serial number and the identification No..

5 Routine Maintenance and Care

5.1 Pickup

- 1) After measuring, put the pickup into the box in time;
- 2) Protect the stylus of the pickup;
- 3) The pickup is a key component to acquire the measurement signal, precise, sensitive and fragile. Handle carefully.

5.2 Host

- 1) Keep the surface clean. Clean with a soft dry cloth to remove the dust;
- 2) The instrument is of precision testers. Handle it carefully to avoid serious vibrations, or damage thus occurred.

5.3 Battery

- 1) Check the battery frequently. Charge in time if the battery is low;
- 2) The charging time is about 3 to 4 hours;

5.4 Calibration specimen

- 1) Keep the surface clean;
- 2) Avoid scratching the calibration specimen work area surface and leading to wrong calibration.

6 Common Faults

Faults	Reasons	Measures
Over range	The pickup and the body not parallel with the surface to be measured	Switch to large range Adjust stylus position
No test data	No measuring after booting	Measure again
Motor problem	Driver blocked	Measure again
Error during running	Abnormal interruption	Re-start

7 Accessories

7.1 Height support and pickup holder

When the measured surface of the workpiece is smaller than the bottom surface of the instrument, you can use the pickup holder and height support in the following optional accessories to support to complete the measurement (as shown below).



Height support and pickup holder

-
- Tips: 1. The dimension L in Figure 1 cannot be less than the driving stroke of the measurements to avoid that the pickup falls outside the workpiece during measuring, causing malfunctioning of the workpiece as the pickup returns against the workpiece.
2. The height support must be locked reliably.
3. Do not adjust the stylus position using the height support during measuring. Adjust the adjustable feet to the desired height before measuring. Measure with calipers to meet the requirements.
-

7.2 Height stand

Use a height stand to adjust the position between the instrument and the workpiece more accurately for more reliable and stable operation, to expand the measuring space and measure larger workpieces. To use a height stand, be careful as the pickup is close to the workpiece, so as to avoid damage to the pickup due to malfunction.

When the pickup is close to the workpiece surface, check the stylus position on the screen carefully. It is OK as the pointer stays in the middle of the display. When the Ra value of the measured surface is small, it is recommended to use the measurement platform. Start the measurement with a remote controller in order to reduce the impact of the external environment on the measurements. To use special pickups, such as aperture, deep groove and curved surface pickups etc., use the column height ruler height gauge or other adjustment equipment.



Height stand

7.3 Standard pickup

The standard pickup is used more, which can measure the roughness of the most flat, slope, conical surfaces, inner holes, grooves and other surfaces. Handheld measurement is available. Except for standard pickups, the measuring platform is required for other pickups.



7.3.1 Size

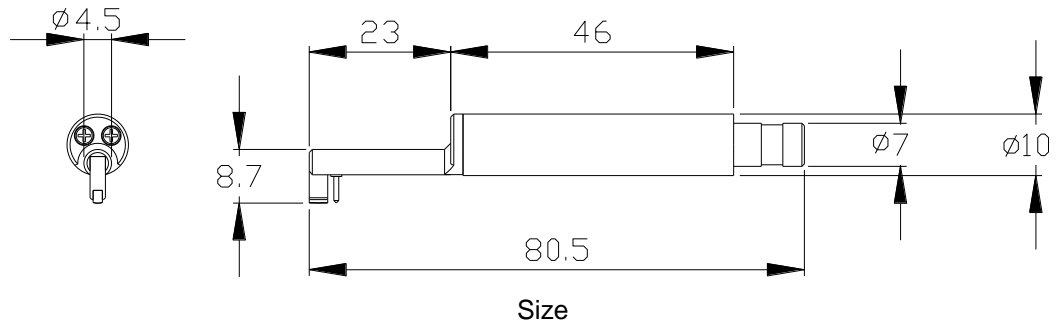

7.3.2 Operating instructions

1) Handheld measurement

After inserting the pickup into the instrument, measure directly on the surface of the workpiece. In addition to setting the correct measurement conditions, make sure to: keep the body of the pickup level; keep the pickup sliding direction perpendicular to the texture of workpieces.

2) Use height stand

See the picture of height stand in section 7.2.

- Insert the standard pickup carefully into the instrument, and then mount it on the column connectors. Lock reliably;
- Adjust the column carriage slightly higher. Lower it until the pickup contacts the workpiece. Be careful, especially as the pickup contacts with the workpiece.
- Adjust the body of pickup level and check visually. Check whether the stylus position is near the center.
- Lift the pickup in proper direction. Wrong direction will cause damage to the pickup.

7.3.3 Calibration

- 1) Measure the multi-line specimen;
- 2) Read the Ra value;
- 3) Compare it with the calibration specimen.

7.3.4 Precautions

- 1) Be careful to plug the pickup. Do not touch the guide and the stylus, which are key parts of the instrument. Try to hold the base of the pickup guide bracket (front body);
- 2) 2) After operating the pickup, place it in the package.

7.4 Curve surface pickup

Curve surface pickups are used to measure the roughness of smooth cylindrical surface with a radius greater than 3mm. Perfect approximation value can be achieved for spherical surfaces with larger radius of and other smooth surfaces, the greater the radius of curvature, the smoother the surface, the better the measurement.



7.4.1 Size

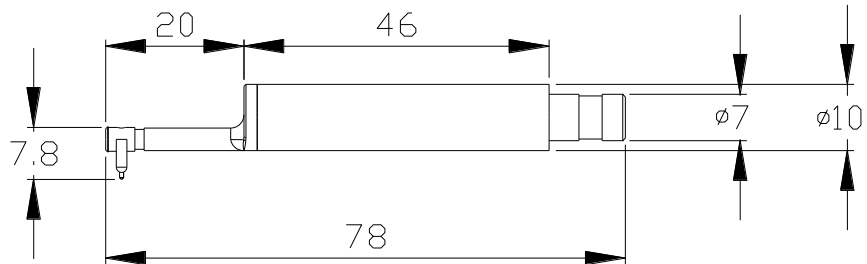

7.4.2 Operating instructions

- 1) Insert the curve surface pickup carefully into the instrument, and then mount it on the column connectors. Lock reliably;
- 2) To use the pickup surface, select a shorter trip as possible, such as: 0.25 sampling level, especially for small arc;
- 3) Adjust the column carriage slightly higher. Lower it until the pickup contacts the workpiece. Be careful, especially as the pickup contacts with the workpiece;
- 4) Keep the stylus of the pickup aligned with the highest (or the lowest) point of the quasi curve surface;
- 5) Adjust the body of pickup level and check visually. Check whether the stylus position is near the center.

7.4.3 Measurement

Before measurement, move the workpiece right to half of the travel. Press Start to start measurement. This is to ensure that the entire measurement travel is symmetry taking the highest point (the lowest point) of the surface as the center.

7.4.4 Calibration

- 1) Calibrate the curve surface pickup using a single-line specimen;
- 2) Calibrate.

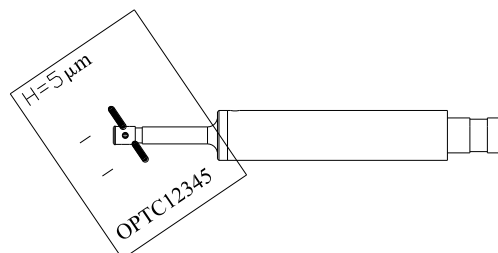

Calibration

As shown in the figure, incline the single-line model at certain angle, so that the guide and the stylus pass the line in order rather than at the same time (which is not the true depth). After measuring, observe the profile graphics. There is a rectangular deep groove, and the groove depth is the single-line value. There are several methods to read the depth of model:

- Read the Rt value, which may be inaccurate as the location is not proper;
- Measure this depth with the mouse using the software;
- Measure the actual depth of the outline on the printer, divided by the magnification.

7.4.5 Precautions

- 1) Be careful to plug the pickup. Do not touch the guide and the stylus, which are key parts of the instrument. Try to hold the base of the pickup guide bracket (front body);
- 2) The main difference between curve surface pickups and other pickups is that its guide and the stylus are parallel, and those for other pickups are in tandem;
- 3) The curve surface pickup cannot be calibrated using a multi-line calibration specimen due to its structure.

7.5 Groove bottom pickup

The groove bottom pickup is close to the standard pickup, but the depth increases. It can measure the roughness of the most flat, slope, conical surfaces, inner holes, grooves and other surfaces. Handheld measurement is not available. Except for standard pickups, the measuring platform is required for other pickups.



7.5.1 Size

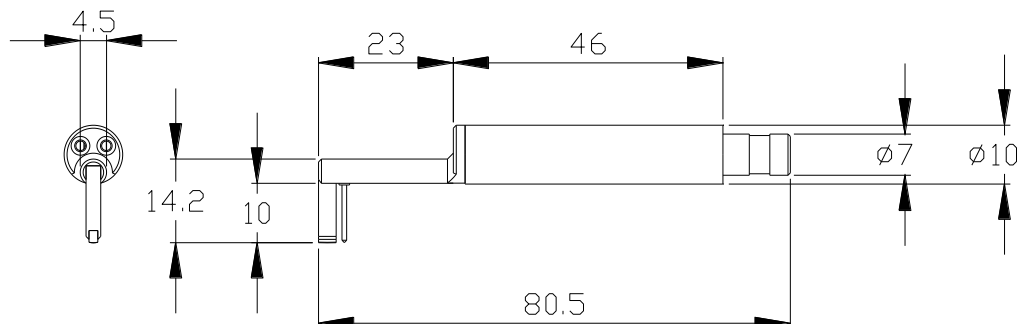

7.5.2 Operating instructions

- 1) Insert the groove bottom pickup carefully into the instrument, and then mount it on the

- column connectors. Lock reliably;
- 2) Adjust the column carriage slightly higher. Lower it until the pickup contacts the workpiece. Be careful, especially as the pickup contacts with the workpiece.
 - 3) Adjust the body of pickup level and check visually. Check whether the stylus position is near the center.
 - 4) Lift the pickup in proper direction. Wrong direction will cause damage to the pickup.

7.5.3 Calibration

- 1) Measure the multi-line calibration specimen;
- 2) Read the Ra value;
- 3) Compare it with the specimen.

7.5.4 Precautions

- 1) Be careful to plug the pickup. Do not touch the guide and the stylus, which are key parts of the instrument. Try to hold the base of the pickup guide bracket (front body);
- 2) After operating the pickup, place it in the package.

7.6 Small bore pickup

The small bore pickup is used for measuring the roughness of surface of inner holes with 2.5mm diameter or larger. The other uses are the same as standard pickups.



7.6.1 Size

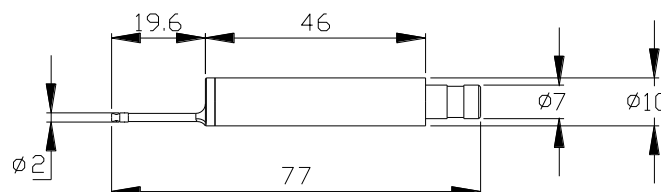

7.6.2 Operating instructions

- 1) Adjustment
 - a. Insert the small bore pickup carefully into the instrument, and then mount it on the column connectors. Lock reliably;
 - b. Adjust the column carriage slightly higher. Lower it until the pickup contacts the workpiece. Be careful, especially as the pickup contacts with the workpiece; In general, keep the pickup body level first, and then tune the stylus position;
 - c. The small bore pickup is not the same as the standard pickup and the groove bottom pickup, and its guide is behind the stylus. As it contacts the workpiece, the stylus is high first

and then low;

- 2) Measure
- 3) Adjust the stylus near the center

7.6.3 Calibration

- 1) Calibrate the small bore pickup using the multi-line calibration specimen;
- 2) Calibrate.
 - a. Measure the multi-line calibration specimen;
 - b. Read the Ra value;
 - c. Compare it with calibration specimen.

7.6.4 Precautions

- 1) Be careful to plug the pickup. Do not touch the guide and the stylus, which are key parts of the instrument. Try to hold the base of the pickup guide bracket (front body);
- 2) The guide of small bore pickup is behind the stylus, so the method to adjust stylus position is not the same as the standard pickup;
- 3) After operating the pickup, place it in the package.

7.7 Extension rod

To use the extension rod, the depth of the pickup into the workpiece can be increased. The length of the extension rod: 50mm.

8 Key Technical Parameters

Name		Content
Measure range	Z-axis (vertical)	320 μ m(Ra=80 μ m)
	X-axis (horizontal)	17.5mm
Resolution	Z-axis (vertical)	0.01 μ m/ \pm 20 μ m
		0.02 μ m/ \pm 40 μ m
		0.04 μ m/ \pm 80 μ m
		0.08 μ m/ \pm 160 μ m
Items	Parameters	Ra, Rq, Rz, Rt, Rp, Rv, RS, RSm, Rz(JIS), Ry(JIS), RSk, R3z, Rmax, Rpc, Rmr, Rku, R Δ a, R Δ q, R δ c, Ry; Rk, Rpk, Rvk, Mr1, Mr2, A1, A2, V0;
	Standard	ISO,ANSI,DIN,JIS
	Graphics	Roughness profile, support curve, direct profile
Filter		RC,PC-RC, Gauss, D-P
Sampling length (<i>lr</i>)		0.25, 0.8, 2.5mm
Evaluation length (<i>ln</i>)		$L_n = l_r \times n$ n=1~5
Pickup	Measuring principle	Displacement differential inductor
	Stylus	Natural diamond, 90° cone angle, 5 μ m tip radius
	Force	<4mN
	Guide	Ruby, sliding direction radius 40mm
	Sliding speed	$l_r=0.25$, $V_t=0.15$ mm/s
$l_r=0.8$, $V_t=0.5$ mm/s		

		$f_r=2.5, V_t=1\text{mm/s}$
		Return $V_t=1\text{mm/s}$
Value error		Not more than $\pm 10\%$
Value fluctuation		Not more than 6%
Power		Built-in lithium polymer rechargeable battery, 8.4V, 800mA charger
Dimension		112×50×47mm
Weight		Approx 360g

8.1 Standard code and name

Code	Name
ISO 4287	International standard
DIN 4768	German standard
JIS B601	Japan industrial standard
ANSI B46.1	U.S. standard

8.2 Roughness parameters range

Parameters	Range
Ra Rq	0.005 μm ~ 16 μm
Rz R3z Ry Rt Rp Rm	0.02 μm ~ 160 μm
Sk	0 ~ 100%
S Sm	1mm
tp	0 ~ 100%

9 References

9.1 Terms

This instrument carries out calculation of parameters based on the filtering profile and the direct profile, in line with GB/T 3505-2000 Geometrical Product Specifications (GPS)--Surface texture: Profile method--Terms, definitions and surface texture parameters.

9.1.1 Terms

Filtering profile: The original profile after removing the waviness components via the roughness filter.

Direct profile: Original profile only after calculating of the center line using least squares method.

RC: Traditional second-order RC filter, in line with the old standard. There are still some users for it, so it is available for the instrument as a transition. There is a phase difference between the input signal and output signal of the filter.

PC-RC: A filter based on the RC filter after a digital phase correction. The amplitude transmission characteristic is the same as the RC filter, basically no phase difference. The amplitude parameters obtained from the RC filter and PC-RC filter are the same.

GAUSS (Gaussian filter): The latest roughness filter, in line with GB/T 18777-2002 Geometrical product specifications (GPS) - Surface texture - Profile method - Metrological characteristics of phase correct filters.

9.1.2 Traversing length

- RC Filter

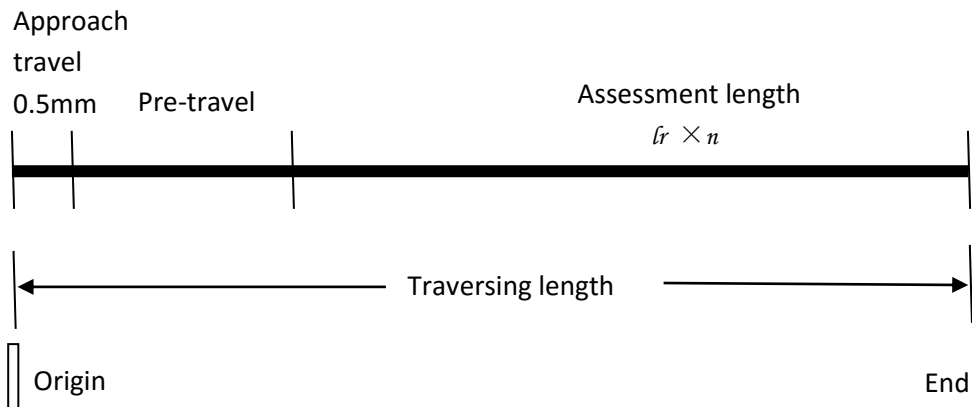

- PC-RC Filter

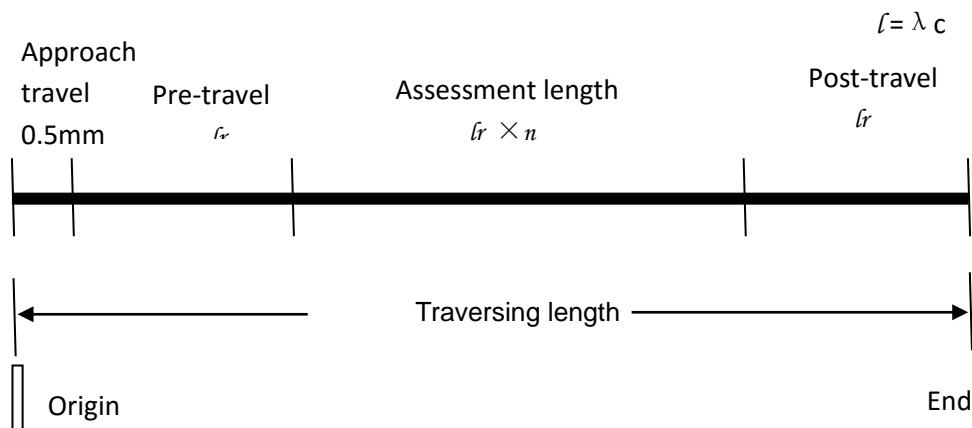

- GAUSS Filter

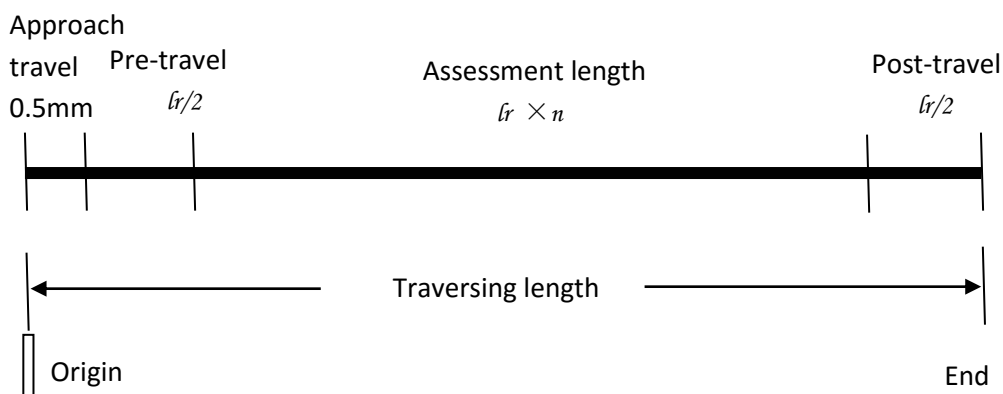

9.2 Definition of parameters

9.2.1 Arithmetic Mean Deviation of Profile Ra

The arithmetic average value of the vertical coordinates' absolute value within one sampling length.

$$Ra = \frac{1}{l} \int_0^l |Z(x)| dx$$

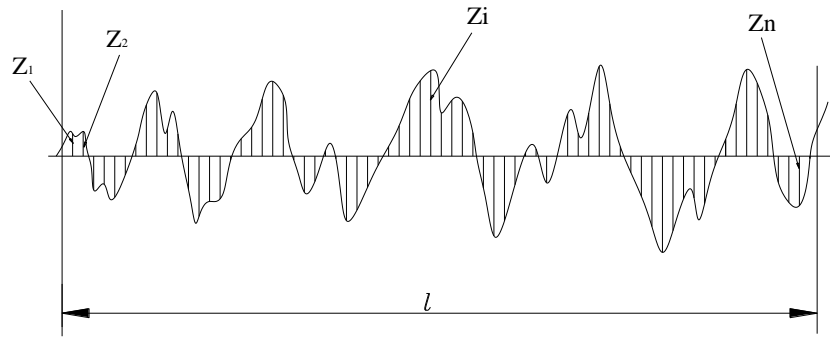

9.2.2 Root-mean-square Deviation of Profile Rq

The root-mean-square value of the vertical coordinate value within one sampling length.

$$Rq = \sqrt{\frac{1}{l} \int_0^l Z^2(x) dx}$$

9.2.3 Maximum height of the profile Rz

The sum height between maximum profile peak height Rp and maximum profile valley depth Rv within one sampling length.

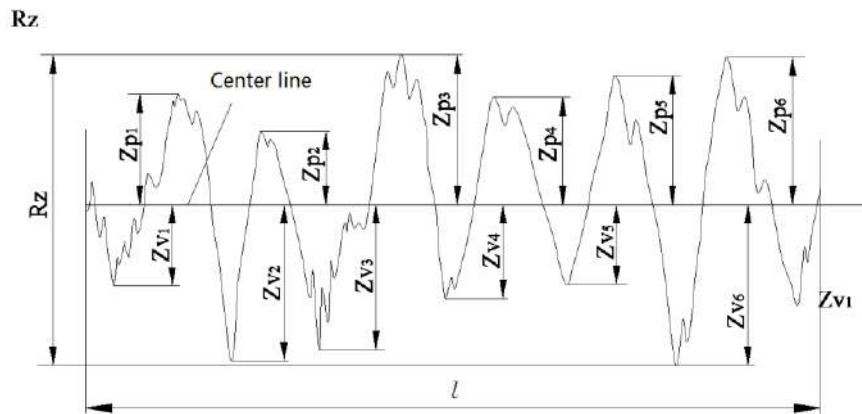

9.2.4 Total Peak-to-valley Height Rt

The sum height between maximum profile peak height and maximum profile valley depth within the assessment length.

9.2.5 Maximum profile peak Rp

Maximum profile peak Zp within an evaluation length.

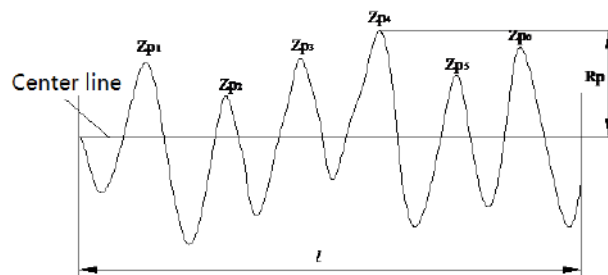

9.2.6 Maximum valley depth R_v

Maximum valley depth Z_v within an evaluation length.

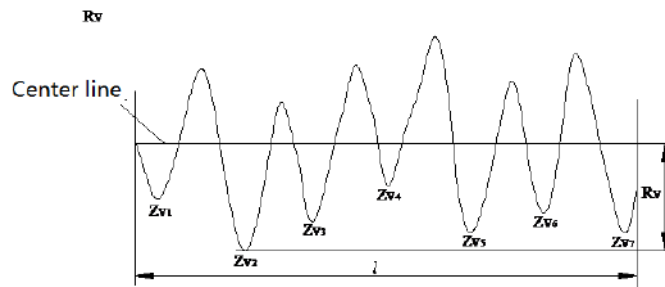

9.2.7 Average distance of profile single peak RS

Average distance of profile single peak X_s within a sampling length.

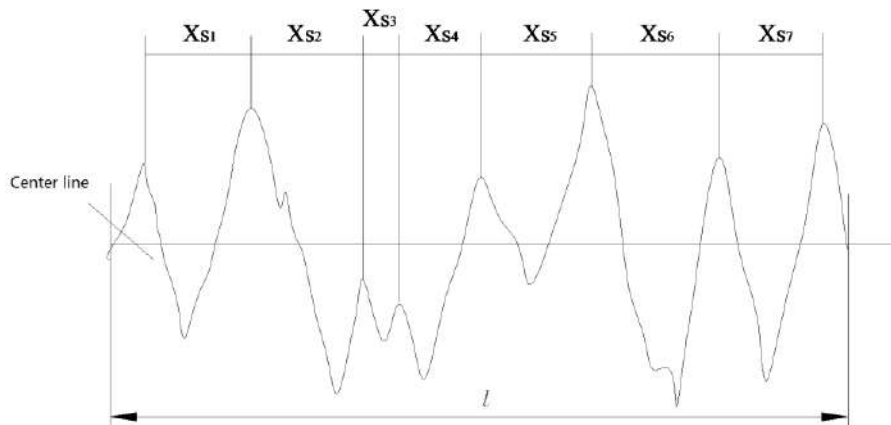

9.2.8 Average width of profile unit RSm

Average width of profile unit X_s within a sampling length.

$$RSm = \frac{1}{n} \sum_{i=1}^m XSi$$

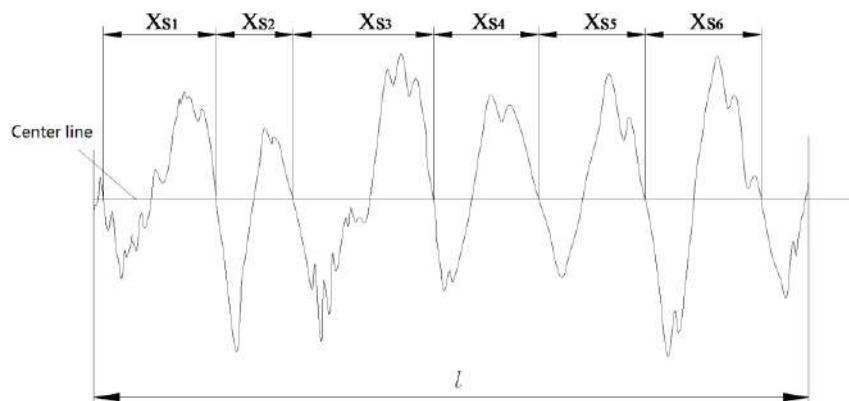

9.2.9 Ten point height for profile microscopic irregularities RzJIS

Sum of the average of the five maximum profile peak height and the average of the five maximum profile valley depth within the sampling length.

$$R_{zJIS} = \frac{1}{5} \sum_{i=1}^5 Y_{p_i} + \frac{1}{5} \sum_{i=1}^5 Y_{v_i}$$

9.2.10 Maximum profile height RyJIS

Same as 9.2.3 Rz.

9.2.11 Profile inclination Rsk

The ratio of the average of cubic of ordinate values Z (x) and the cubic of Rq within a sampling length.

$$R_{sk} = \frac{1}{R_q^3} \left[\frac{1}{l_r} \int_0^{l_r} Z^3(x) dx \right]$$

9.2.12 Average peak-to-valley height R3z

The average of the vertical distances between the third peak and the third valley of various sampling lengths within the evaluation length.

$$R_{3z} = \sum_{i=1}^{i=n} R_{3zi}$$

Note: five sampling lengths are recommended for evaluation.

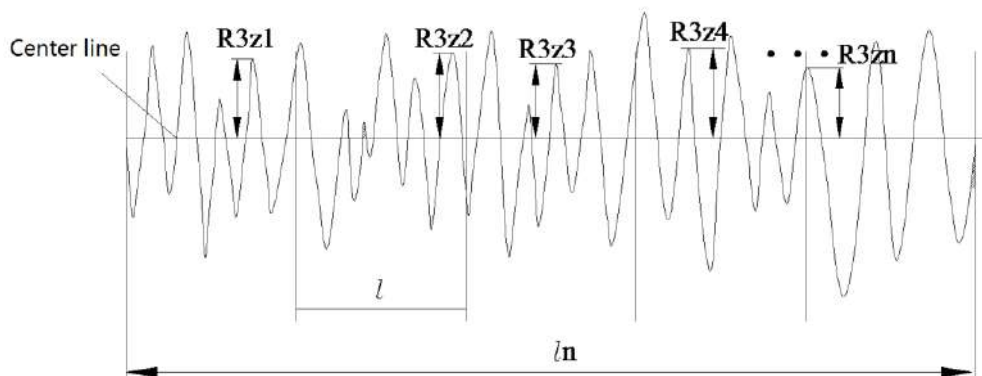

9.2.13 Rmax

Same as 9.2.4 Rt.

9.2.14 Peak count Rpc

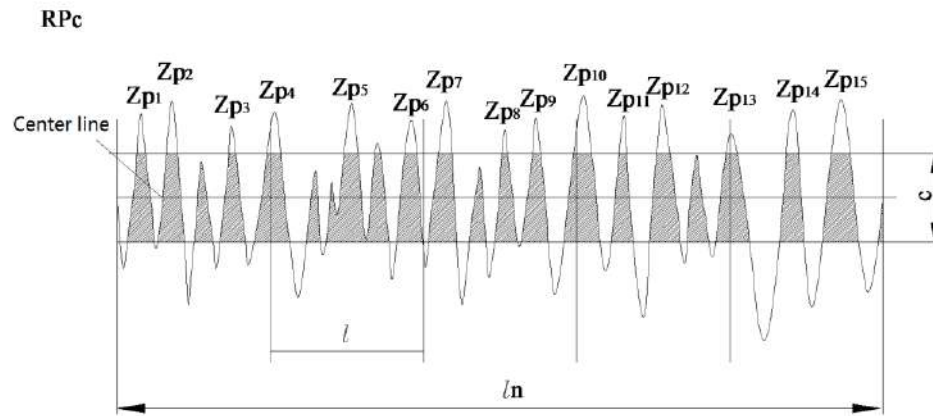

The value C in the figure is the distance between the two lines symmetry based on the center line and parallel with the center line. There are two types of C value: one is the absolute value of the actual distance; the other is the relative percentage. Determine the C value required for assessment first. Then calculate Rmrc peak counts. A peak higher than C value and an adjacent valley lower than C value form a number of Rmrc peak count. Rmrc is calculated and assessed based on the evaluation length using the following formula:

$$Rmrc = \frac{\text{Peak count}}{\text{Evaluation length (cm)}} = \text{Peaknumber/cm}$$

9.2.15 Profile support rate curve Rmr

Curve of profile support rate v.s. horizontal positions.

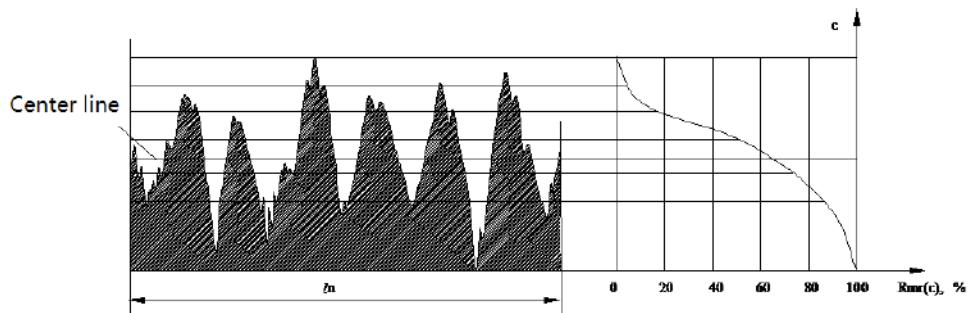

9.2.16 Profile support length rate Rmr(c)

Ratio of length of the material at a given level position C of profile and the evaluated length.

$$Rmr(c) = \frac{\text{Support length (c)}}{\text{Evaluated length}}$$

9.3 Sampling length selection recommendation form

Ra (μm)	Rz (μm)	Sampling length (mm)
> 5~10	> 20~40	2.5
> 2.5~5	> 10~20	
> 1.25~2.5	> 6.3~10	0.8
> 0.63~1.25	> 3.2~6.3	
> 0.32~0.63	> 1.6~3.2	
> 0.25~0.32	> 1.25~1.6	0.25
> 0.20~0.25	> 1.0~1.25	
> 0.16~0.20	> 0.8~1.0	
> 0.125~0.16	> 0.63~0.8	
> 0.1~0.125	> 0.5~0.63	
> 0.08~0.1	> 0.4~0.5	
> 0.063~0.08	> 0.32~0.4	
> 0.05~0.063	> 0.25~0.32	
> 0.04~0.05	> 0.2~0.25	
> 0.032~0.04	> 0.16~0.2	
> 0.025~0.032	> 0.125~0.16	
> 0.02~0.025	> 0.1~0.125	

Sino Age Development Technology
Building 5, TEDA Raycom Park, No.12 Zhu Yuan Rd.,
Tianzhu Shunyi, 101312, Beijing, China
TEL: +86 (10) 8260-0228, 5166-3600
FAX: +86 (10) 8260-0229
sadt@sinoage.com.cn
www.sadt.cn