

NDTKALA[®].CO
Non-Destructive Test (NDT) Equipment



تامین تجهیزات و مواد مصرفی تست های غیر مخرب با ایران

۰۲۱-۷۱۰۵۳۸۸۸ ۰۹۱۲۰۲۴۶۲۷۰



MODEL: GM63A

Vibration Meter User's Manual



Standard: Q/GMY 002-2016
Version: GM63A-EN-02



Contents

1. Before use

- Check-up-----(01)
- Introduction-----(02)
- Features -----(02)
- Specifications -----(03)
- Diagram of the product ----- (04)
- LCD displays ----- (05)

2.Operation

- Selecting probe tip----- (06)
- Battery installment----- (07)
- Turn on the unit and check-up battery -----(08)
- Select measurement mode----- (09)
- Select high/low frequency----- (10)
- Measurement----- (11)
- Vibration conversion chart----- (13)
- Contact resonance in acceleration measurement
----- (14)

3. Other items

- Attentions ----- (16)
- Warranty----- (16)
- Maintenance ----- (17)

Maintenance

1. Replacement and upkeep of battery:
 - a. After power on, if an icon  appears on the LCD, you need to replace the battery immediately, for details please refer figures and contents on page 9 of this manual.
 - b. Remove the battery from the unit if it is not required for extended periods of time in order to avoid damage to the battery compartment and the erosion resulting from a battery leakage.
2. Do not store or use the unit in following circumstances:
 - a. Splashes of water or high levels of dust.
 - b. Air of high salt or sulphur content.
 - c. Air mixed with other gases or contents.
 - d. High temperature or humidity (above 50°C, 90%,) or direct sunlight.
3. Do not disassemble the unit or attempt any internal alterations.
4. Never use alcohol or diluents to clean the housing for doing that will especially erode the LCD surface; just clean the unit lightly as needed with little clean water.



Specific Declarations:

Our company shall hold no any responsibility resulting from using output from this product as an direct or indirect evidence. We reserves the right to modify product design and specification without notice.

3. Other items

Attentions

Warning

When making measurements on exposed rotating parts or power train parts of machinery, proceed with utmost care to prevent accidents due to getting caught in the machinery.

Caution

If the unit shook excessively, the receiver may produce extremely high sound pressure that hurts human ear, be careful in process of using the signal output plug.

Warranty

1. About relative warranties please read warranty card.
2. We disclaim any liability due to: client's transportation damages; incorrect use or operation; manipulation, alterations or repair attempts; without warranty card, invoice.

1. Before use

Check-up

Carefully unpack your kit and ensure that you have the following items. In case that any item is missing or if you find any mismatch or damage, promptly contact your dealer.

- | | |
|--|------|
| <input type="radio"/> Vibration meter | 1PCS |
| <input type="radio"/> 9V Alkaline battery | 1PCS |
| <input type="radio"/> User's manual | 1PCS |
| <input type="radio"/> Long probe | 1PCS |
| <input type="radio"/> Short probe (Equiped on the main unit) | 1PCS |
| <input type="radio"/> PP packing box | 1PCS |

Introduction

This product adopts piezoelectric effect of artificial polarized ceramic for design. It is suitable for monitoring all kinds of vibrating mechanical facility, specially the vibration measurement of rotating and reciprocating machinery. The unit can measure acceleration, velocity and displacement, which is widely used in mechanical manufacture, electric power metallurgy and general aviation etc.

Features

- Simple to use, the structure is compact, portable for carrying along with measurement.
- Visually display measurement value and state.
- Acceleration, velocity and displacement measurement.
- Different vibration frequency selection.
- High sensitivity probe for accurate measurement Provides long and short probe head ,each one is suitable for different situation measurement.
- Equipped with AC signal output interface.
- Low power indication.
- Auto power-off.
- LCD backlight.

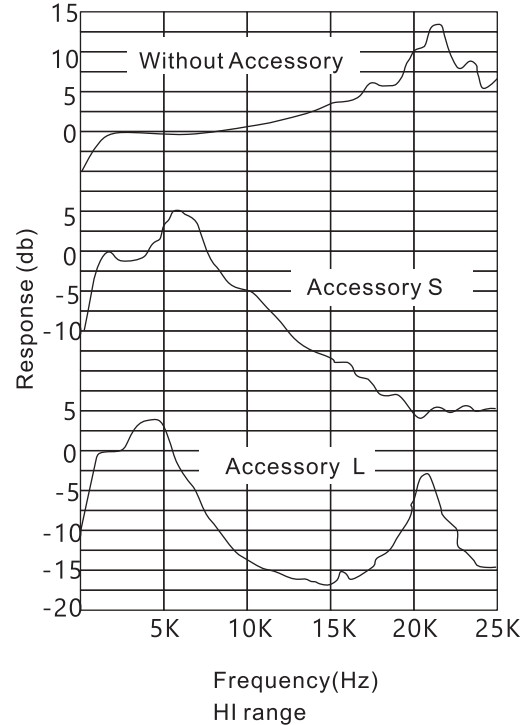

**Contact resonance in acceleration measurement:
(worked with FFT signal analyzer)**

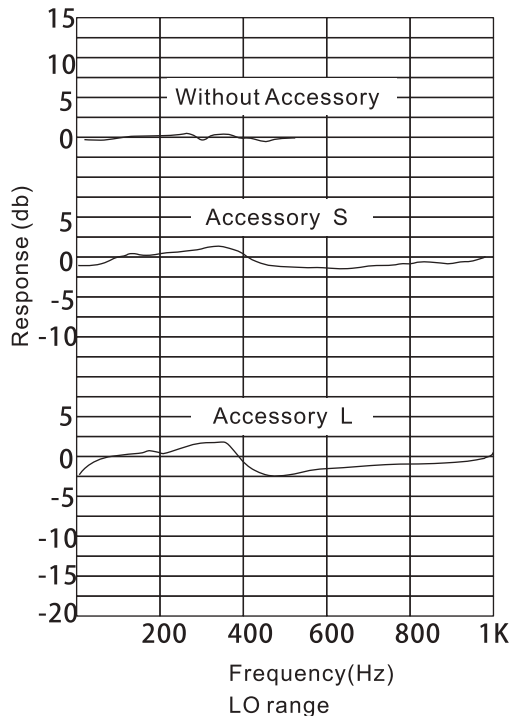

Specifications



Technical parameter	Technical specification
Vibration pickup	Piezoelectric ceramic accelerometer (shear-type)
Measurement range of acceleration	0.1~199.9m/s ² peak
Measurement range of velocity	0.1~199.9mm/s rms
Measurement range of displacement	0.001~1.999mm p-p Velocity and displacement range is limited by acceleration
Measurement accuracy	±5%±2digits
Measurement frequency range of acceleration	10Hz~1KHz (LO) 1KHz~15KHz (HI)
Measurement frequency range of velocity	10Hz~1KHz (LO)
Measurement frequency range of displacement	10Hz~1KHz (LO)
Displays update cycle	1 second
LCD display	3 1/2 digits display
	AC output 2 V peak (display full scale)
Single output	Load impedance 10KΩ or more earphones can be connected
Power supply	9V Alkaline battery
Static current	≤20 μA
Operating current	≤25mA
Battery life	20 hours continuous use
Auto power-off	Turns off automatically in 60 seconds
LCD backlight	7 seconds

Operating temperature range 0~40°C

Operating humidity range 80~90%RH

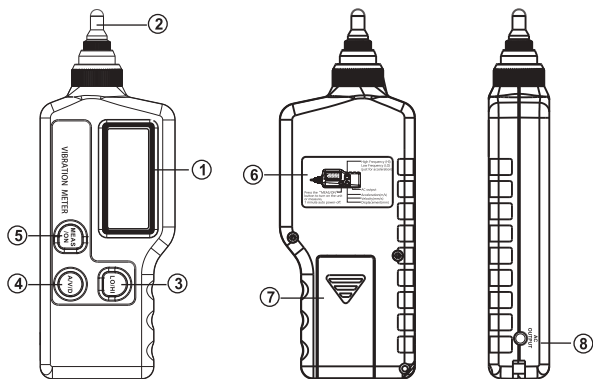
Diagram of the product



- 1). LCD screen
- 2). Probe
- 3).  Frequency selection key (only in acceleration measurement)
- 4).  Measurement mode (acceleration / velocity / displacement) selection key
- 5).  Power on and measurement key, Press once to turn on the unit , Keep pressing during the measuring process, Release it to hold the data.
- 6). Quick instruction label
- 7). Battery door
- 8). AC signal output jack

Vibration conversion chart

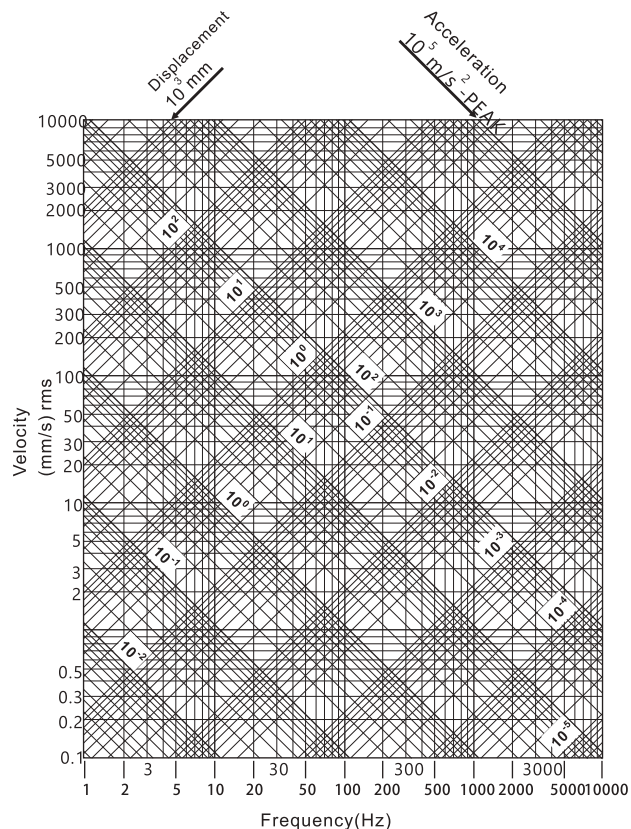



- b. When the **MEAS/ION** key is pressed again, the current value will be canceled, and a new measurement can be performed.



Note:

- Using short Probe (S) can take measurement of vibration both in high(HI) and low(LO) frequency.
- Long Probe (L) is only suitable for low frequency measurement. When taking acceleration measurement, or when the frequency is over 1KHZ, please replace the short probe.
- When switching acceleration (HI high frequency) measurement mode to velocity or displacement mode, the high frequency (HI) will be changed to low frequency (LO) automatically.
- Power turns off automatically in 60 seconds without any operation.
- The backlight will be turned off in 7 seconds without any operation.

LCD Display

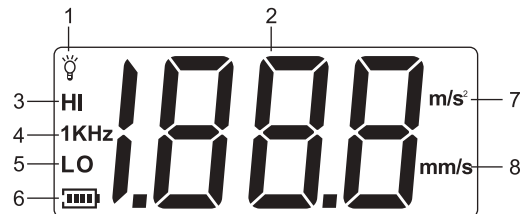

- Backlight indication, the backlight will be activated for 7 seconds upon the button operations.
- Measurement data
- HI** High frequency
- 1KHz** 1KHZ frequency
- LO** Low frequency
- Battery mark shows battery power. Has following 5 levels:
 - :battery is sufficient
 - :battery is comparative sufficient
 - :battery is nearly deficient
 - :battery is nearly exhausted, need replace a new one.
 - :battery is exhausted completely.
- m/s²** When taking measurement of acceleration, the LCD displays the acceleration unit: m/s²
- mm/s** When take measurement of velocity, the LCD displays the velocity unit: mm/s; When taking measurement of displacement, the LCD displays the displacement unit: mm.

2. Operation

Select Probe tip

Probe tip is used as following 3 conditions, please probe according to actual condition:

a. Measurement with short (S) probe tip: this probe tip is factory default installment, adapts in wide scope vibration measurement, and obtains good response value, as shown in following figure:

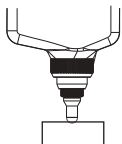

b. Measurement with long (L) probe tip: this probe tip is packed inside the carry box, mainly adapts in narrow objects or special objects field, the unit will response quickly, as shown in following figure:

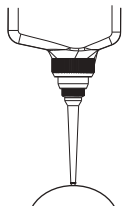

c. Measurement without probe tip: adapts in smooth object surface measurement to get stable value, as shown in following figure:

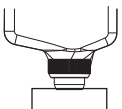

Measurement

As per the to-be-measured and frequency of vibration structure, select corresponding measurement mode (Acceleration/ Velocity/ Displacement) and frequency (HI/LO frequency). Keep the "MEAS/ION" key depressed with your right thumb, press the vibration meter against the measurement object at a force of 500g to 1kg, the result is displayed on the LCD screen. Release the key and the result is held on the LCD screen. As shown in following figure:

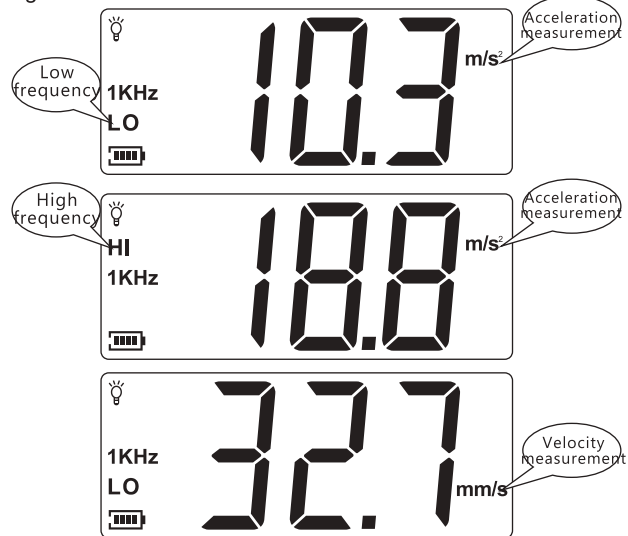

Select High/low Frequency:(High frequency is only for acceleration measurement mode)

- A. press the  key to select high frequency (HI) or low frequency (LO) , as shown in following figure:



Note:

High/low frequency selection is only available in acceleration measurement mode.

Battery Installation

- a. Grip tightly the unit body with your left hand; hold down the battery door with your right hand thumb to open it according to the arrow referring direction, as shown in following figure:

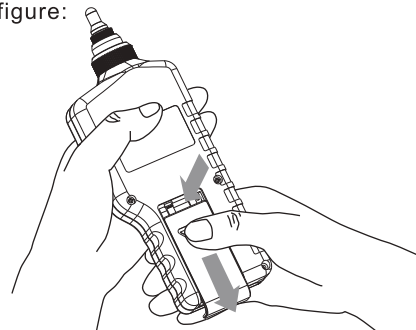

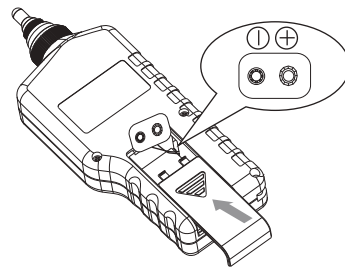

- b. Insert a 9V battery into battery compartment, note the battery polarity, and then close the battery door, as shown in following figure:

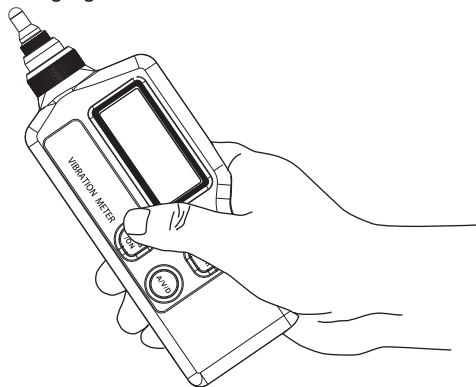

Turn On The Unit And Check-up Battery

- a. Press the  key to turn on the unit, as shown in following figure:



- b. After the entire screen displays for 1 second, the default state is acceleration mode, if on the LCD displays the symbol  or  , please promptly replace the battery, as shown in following figure:



Low battery indication

Select Measurement Mode

- a. Press the  key to select measurement mode, the default mode is acceleration mode, as shown in following figure:



- b. Press the  key to enter velocity measurement mode, as shown in following figure:



- c. Press the key again to enter displacement measurement mode, as shown in following figure:

